

49IRL - CS001 - ROOF RACK

FITTING FOR:

VOLKSWAGEN T6.1 2019+ LWB (L3)



INSTALLATION INSTRUCTIONS

ATTENTION!

- Check the box before installation.
- Read the guide before installation for your safety and making complete installation.
- Make the installation according to the installation guide otherwise, our company has no responsibility for any damage.
- If you any have questions please contact our company.

INSTALLATION OF CROSS PROFILES

WARNING: THIS PROCESS WILL BE MADE BEFORE 5TH STEP IN THE PRODUCT GUIDE.

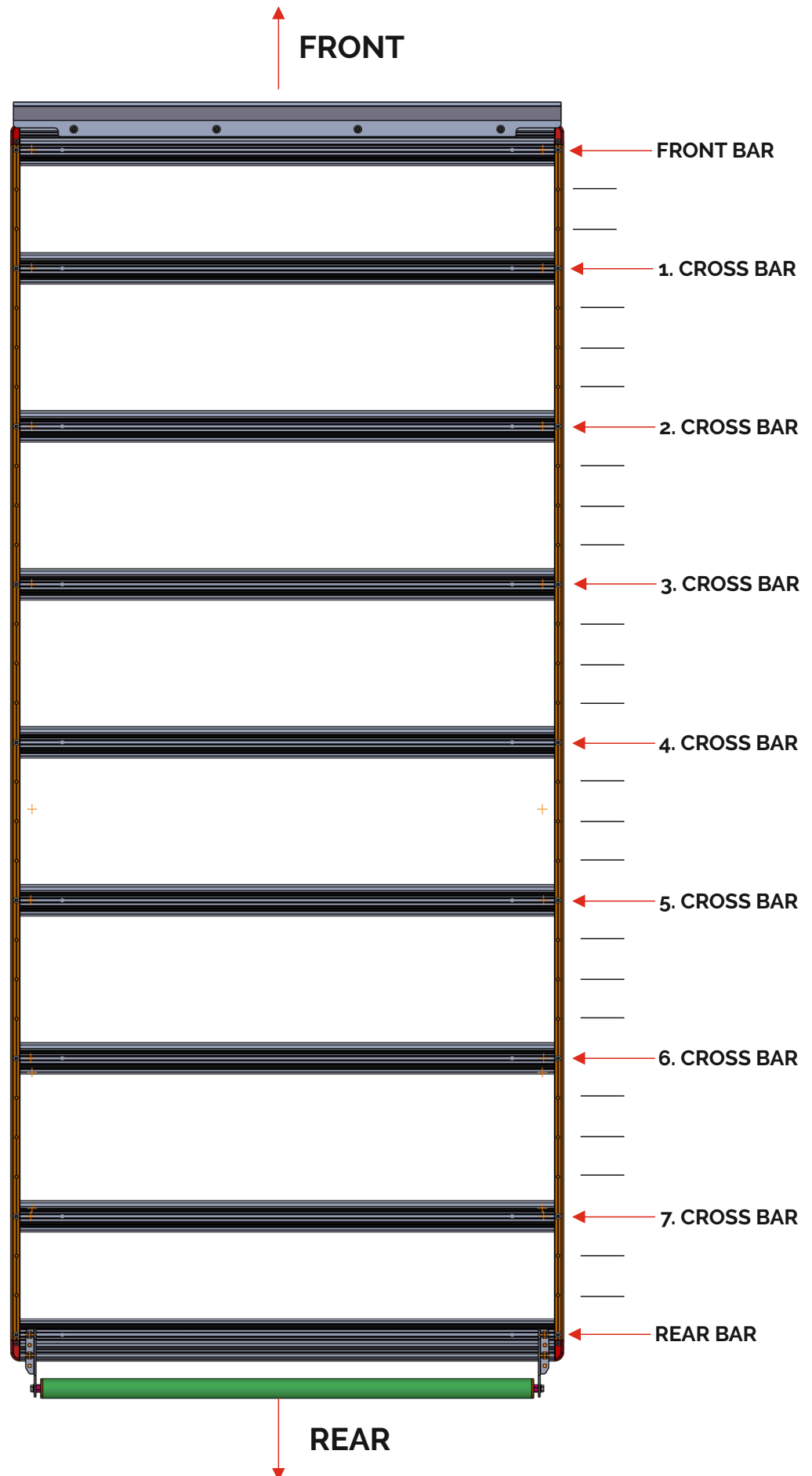

CROSS PROFILES WILL BE MOUNTED AS SHOWN ON FIGURE ABOVE.

NECESSARY MATERIALS

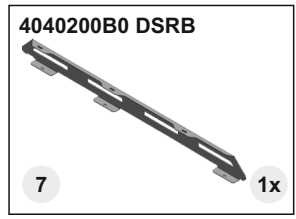
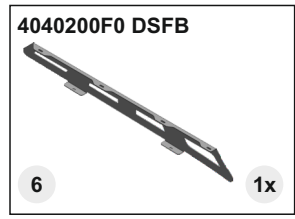
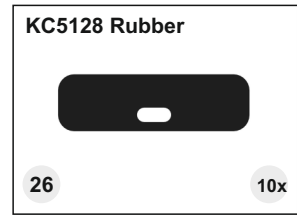
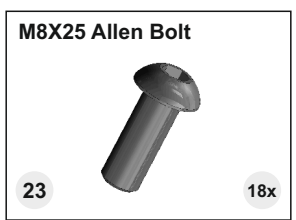
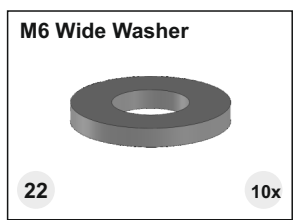
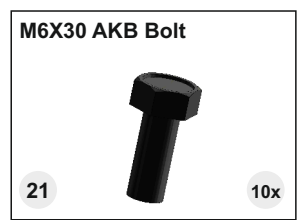
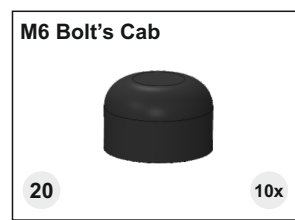
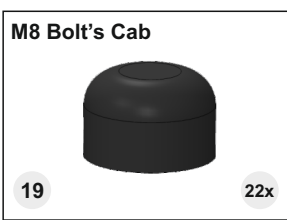
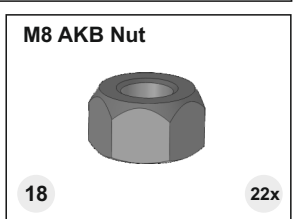
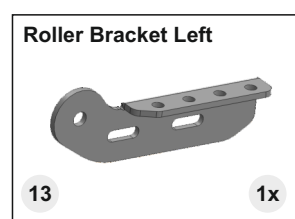
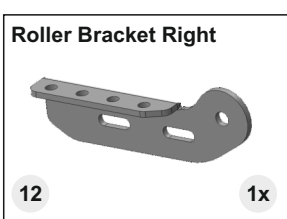
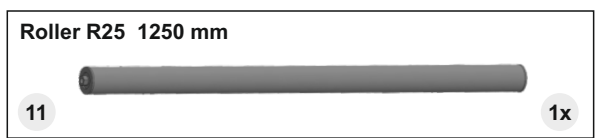
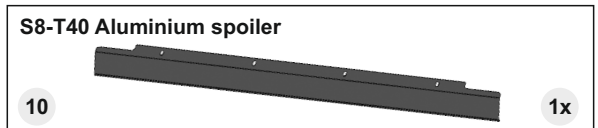
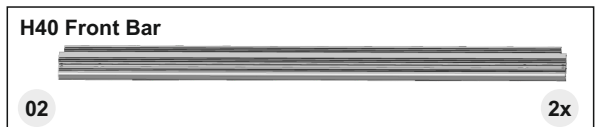
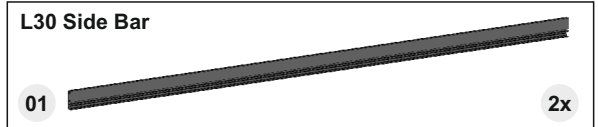
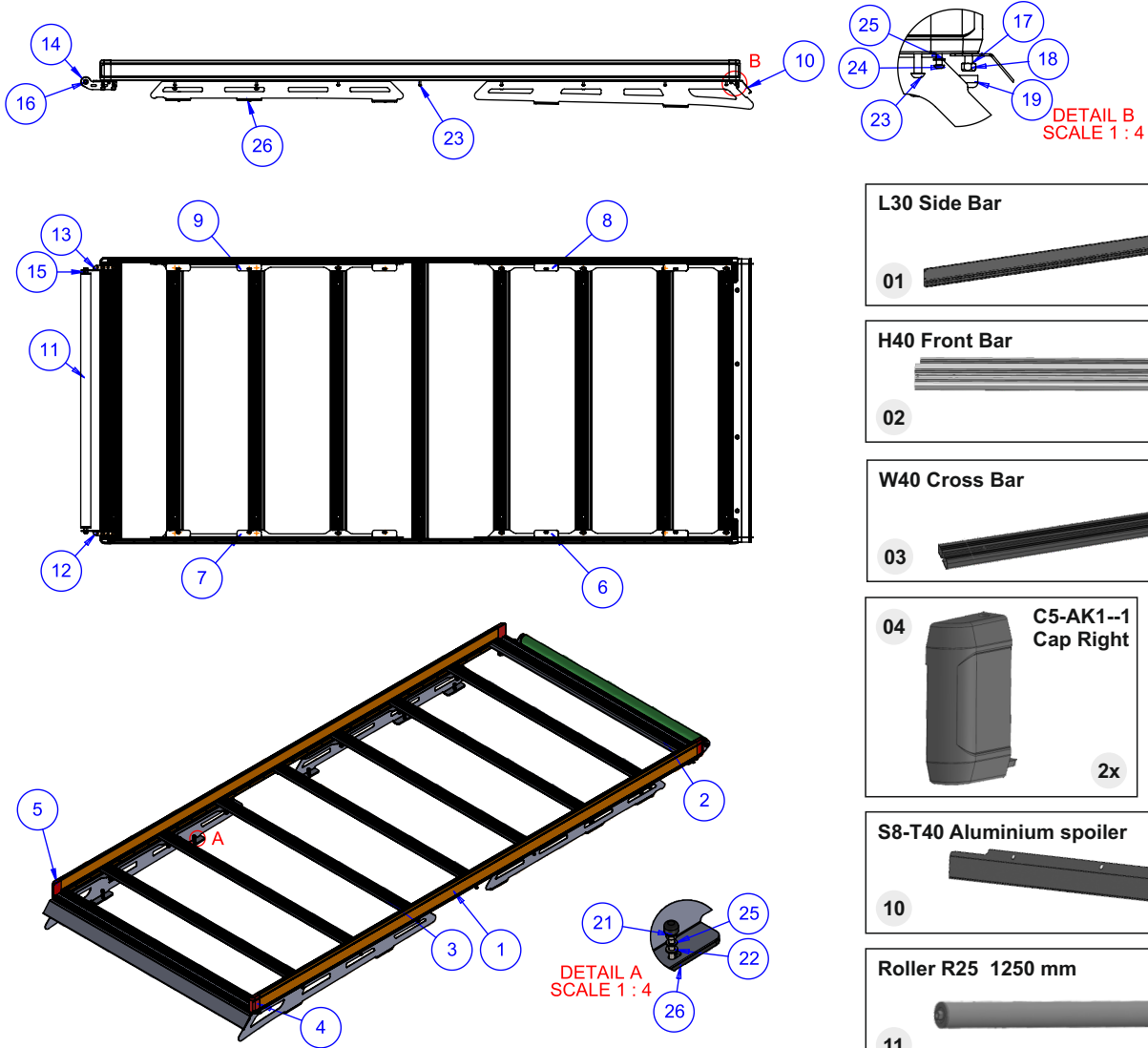

NECESSARY TOOLS

Allen Key 5 mm
Spanner 13 mm
Meter

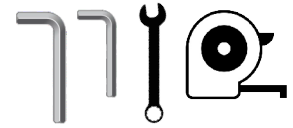

ITEM NO.	PART NUMBER	DESCRIPTION	QTY.
1	L30	Side Bar	2
2	H40	Front Bar	2
3	W40	Cross Bar	7
4	C5-AK1--1	Cap Left	2
5	C5-AK1--2	Cap Right	2
6	4040200F0	Driver Side Front Bracket	1
7	4040200B0	Driver Side Rear Bracket	1
8	4040200F0	Passenger Side Front Bracket	1
9	4040200B0	Passenger Side Rear Bracket	1
10	S8-T40	Aluminium Spoiler	1
11	Roller R25	1250mm	1
12	Roller Yan Aparat	Left	1
13	Roller Yan Aparat	Right	1
14	P9-C3 R2	Roller Plastic	2
15	P9-C3 R3	M10 Nut	2
16	M10 x 20 AKB Bolt	Stainless-Chrome	2
17	M8 x 20 AKB Bolt	Stainless-Chrome	22
18	M8 AKB Nut	Stainless-Chrome	22
19	M8 Bolt's Cab	Black-Plastic	22
20	M6 Bolt's Cab	Black-Plastic	10
21	M6 x 30 AKB Bolt	Stainless-Chrome	10
22	M6 Wide Washer	Stainless-Chrome	10
23	M8 x 25 Allen Bolt	Stainless-Chrome	18
24	M6 x 16 Allen Bolt	Stainless-Chrome	4
25	M6 Spring Washer	Stainless-Chrome	14
26	KC5128	Rubber-Black	10
27	Sista Silicon	Silicon Package	1

INSTALLING BRACKETS TO THE ROOF RACK

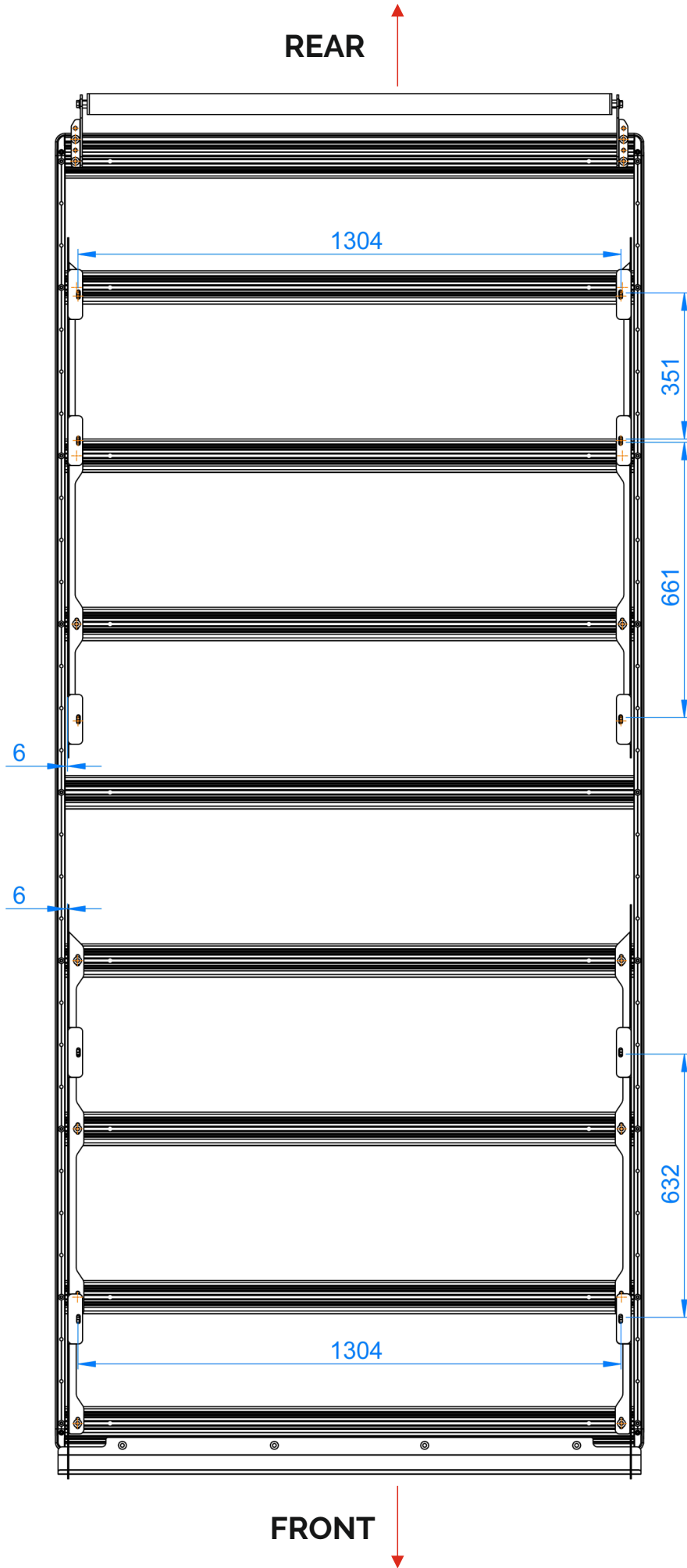

ASSEMBLY OF THE ROOF RACK ON THE VEHICLE

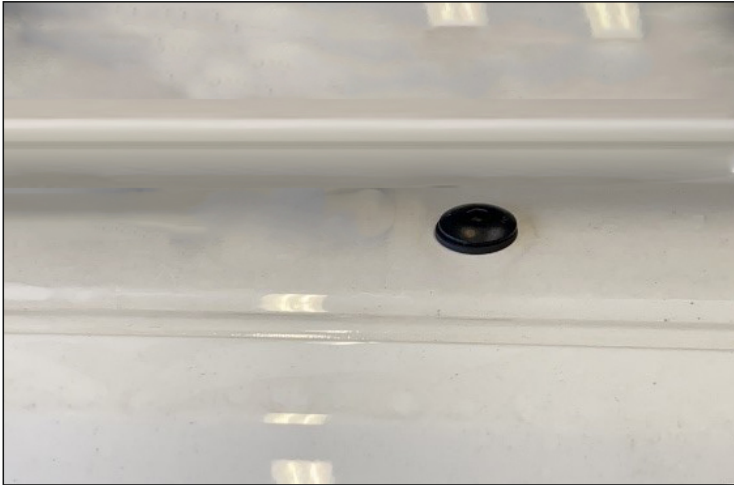

STEP-1 Remove factory rubber plugs as shown.

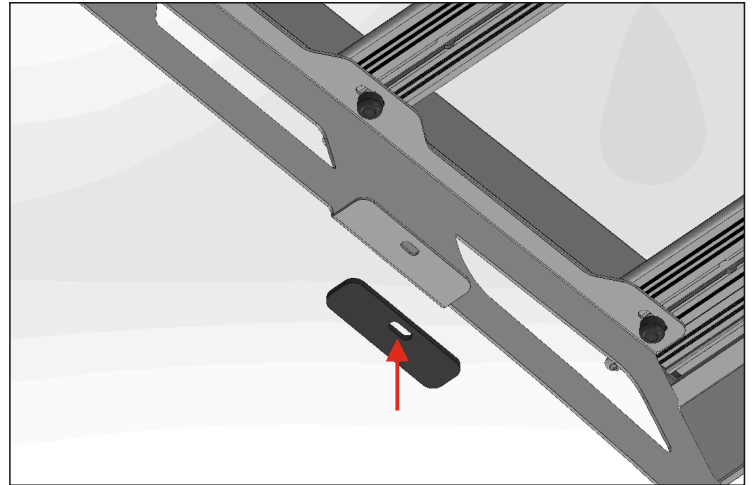

STEP-2 Put supplied rubber part in the bottom part of the bracket on the vehicle.

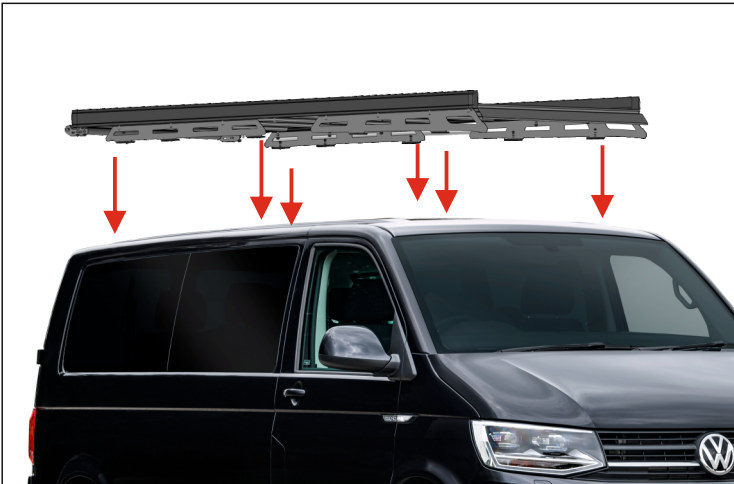

STEP-3 Match holes of the assembled roof rack to holes on the vehicle.

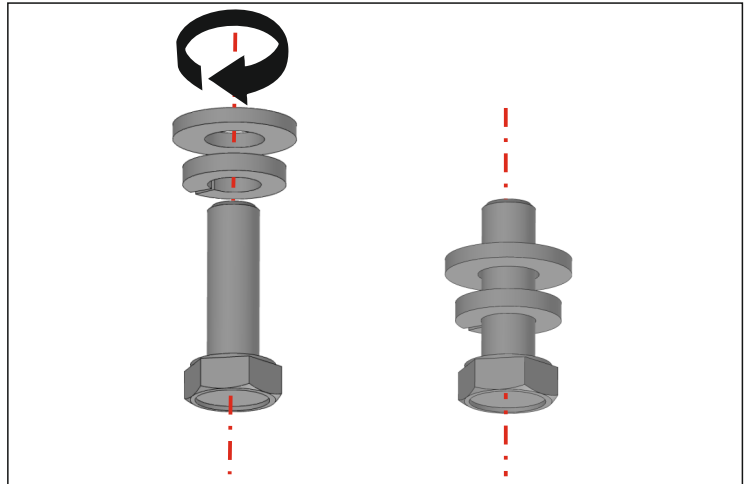

STEP-4 Attach spring washer first then flat washer to M6x25 hex bolts

STEP-5 Apply the silicon around the hole and pass to 6th step before it gets dry.

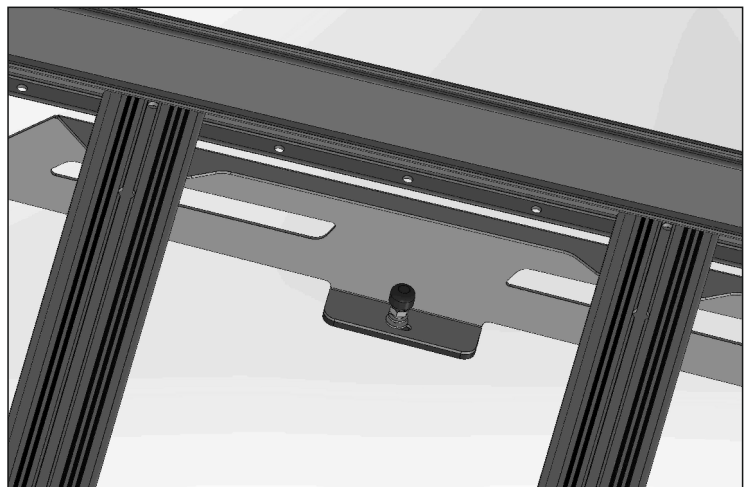

STEP-6 Fix the bracket with bolt to the holes on the vehicle. Repeat this process for all brackets.

CONTROL ALL INSTALLATION AND FINISH ASSEMBLY AFTER INSTALLING PLASTIC BOLT CAPS TO HEX NUTS AND HEX BOLTS