

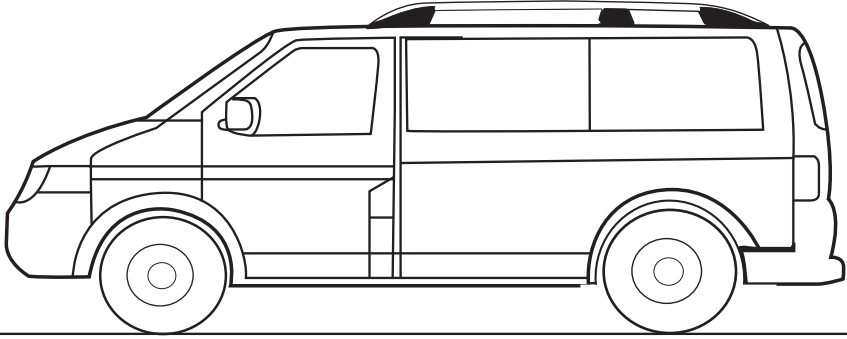

**ONTEC**  
AUTO ACCESSORIES.CO



**VW T5 Transporter  
VW T5 Caravelle  
VW T5 Multivan** **2003>**

<b>TR</b>	<b>Montaj Talimatı</b>	:	<b>PORT BAGAJ</b>
<b>GB</b>	<b>Fitting Instructions</b>	:	<b>ROOF RACK</b>
<b>D</b>	<b>Montageanleitung</b>	:	<b>DACHRELING</b>
<b>F</b>	<b>Instructions de Montage</b>	:	<b>RIDELLES DE TOIT</b>

**TR**

\*Port bagaj taşıma kapasitesi 75 kg. olup; yükleme yapmadan önce aracın tavan taşıma kapasitesinin dikkate alınması gerekir.

**GB**

\*Roof Rack carrying capacity is maximum 75 kg. Please check your vehicle roof maximum carrying capacity from your car manufacturer before load roof rack.

**G**

\*Maximale Traglast unsere Dachrelinge betragen 75kg. Die freigegebenen Dachlasten der Fahrzeughersteller dürfen nicht überschritten werden. Bitte zur Kenntnisnahme!

**F**

\*La capacité de chargement maximale est de 75 Kg. Nous vous prions de vérifier la capacité de chargement du toit de votre véhicule avant de charger les barres de toit.



30 Min.

①



02.09.2014

# PARÇA LİSTESİ

## Part List / Teilleiste / Lista de accesorios

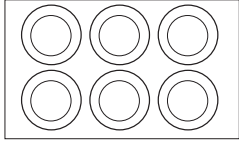

- (TR) PUL = 6 PARÇA
- (GB) RING WASHER = 6 PIECES
- (D) UNTERLEGSCHIBE = 6 STUCK
- (F) RONDELLE AUTOBLOQUANTE = 6 PIECES

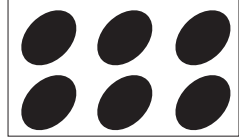

- (TR) PLASTİK TAPA = 6 PARÇA
- (GB) PLASTIC PLUG = 6 PIECES
- (D) GUMMISTOPFEN = 6 STUCK
- (F) BOUCHON PLASTIQUE = 6 PIECES

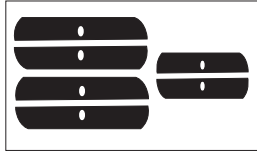

- (TR) BRAKET = 6 PARÇA
- (GB) BRACKET = 6 PIECES
- (D) HALTERUNG = 6 STUCK
- (F) PATTE DE FIXATION = 6 PIECES

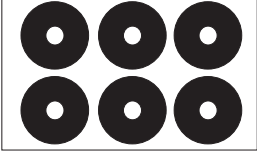

- (TR) SIZDIRMAZLIK ELEMANI = 6 PARÇA
- (GB) IMPERMEABLE RUBBER = 6 PIECES
- (D) KUNSTSTOFF-DICHTUNG = 6 STUCK
- (F) JOINT EN PLASTIQUE = 6 PIECES

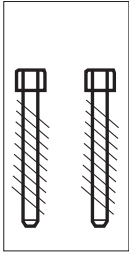

m-6 x 60 (FRONT-2 PIECES)

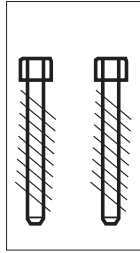

m-6 x 80 (MIDDLE-2 PIECES)

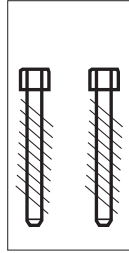

m-6 x 60 (REAR-2 PIECES)

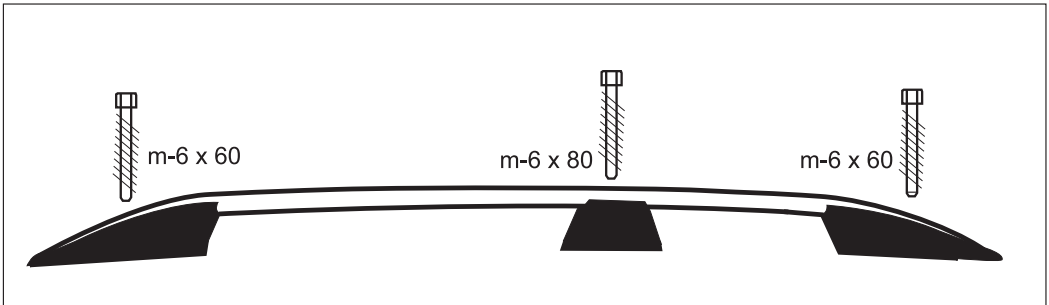

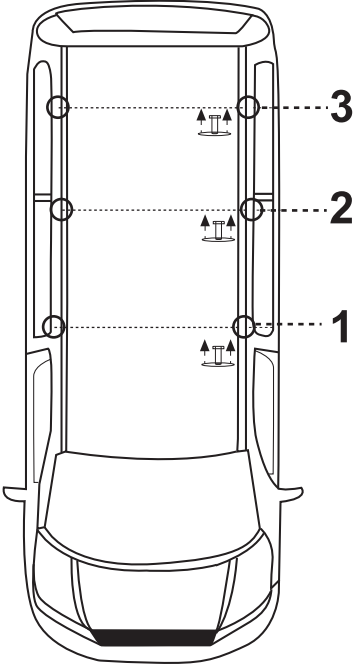
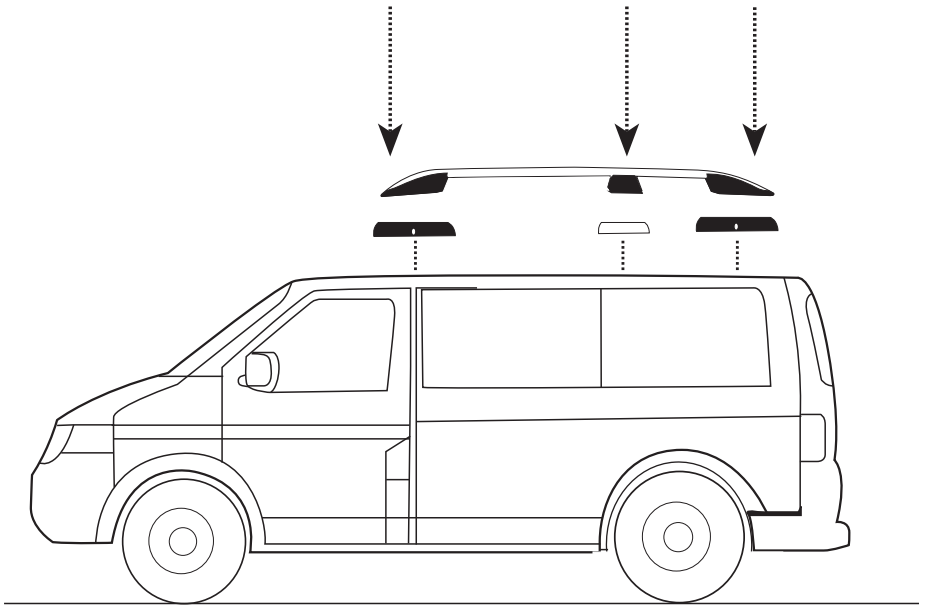

**1) 1-2 ve 3 Numaralı civataları araç üzerinden çıkartınız.**

1) Please pull off the numbered screws (1-2-3) from the vehicle.

1) Entnehmen Sie die Schrauben die auf den Dach vormontiert worden sind.

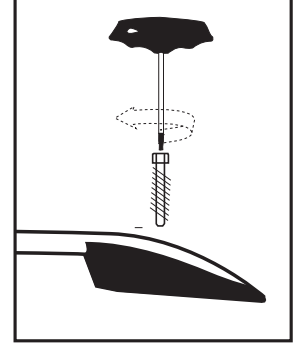
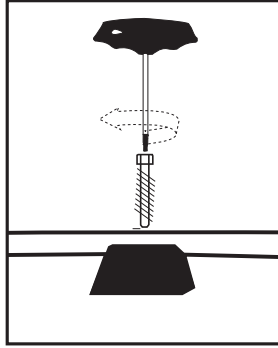
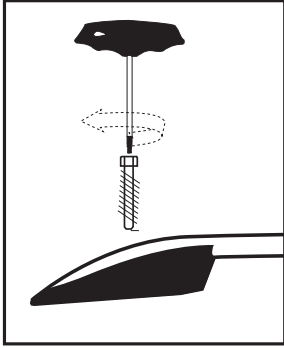

**2)Port Bagajı araç üzerine montaj yerlerinden sabitleyip sıkınız.**

*2)Align the holes in each rails with the hole on the roof then install roof rails by tighten the screws*

*2)Fixieren Sie den Dachträger an den Montierstellen und befestigen Sie diesen.*

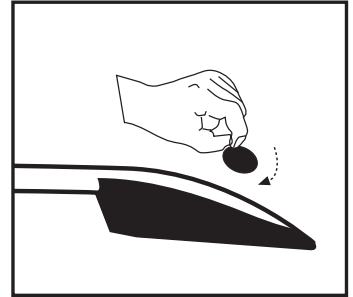
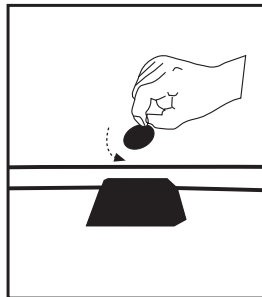
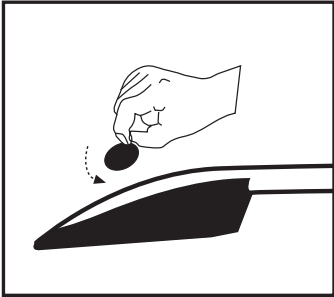

**3)Port Bagajın tapalarını yerlerine yerleştirerek montajı tamamlayınız.**

*3)Tap the plugs on roof rails.*

*3)Stecken Sie die Stopper in Ihre Plätze und schließen Sie diese.*