



**Fiat (E) - Ducato (2006+)**  
**Peugeot (E) - Boxer (2006+)**  
**Citroen (E) - Jumper (2006+)**  
**Opel (E) - Movano (2022+)**

## INSTALLATION GUIDE



60 min.

M8 = 25 Nm  
M10 = 50 Nm  
M12 = 84 Nm

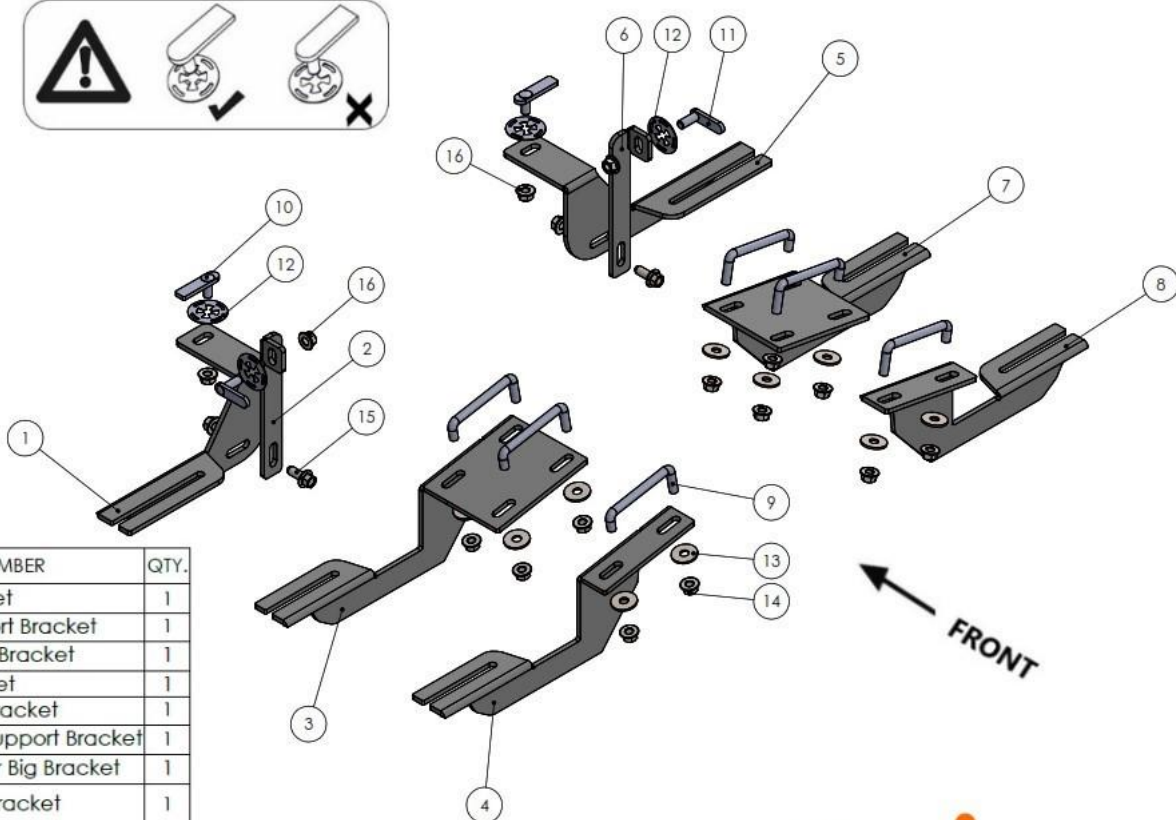
ITEM NO.	PART NUMBER	QTY.
1	DriverFront Bracket	1
2	DriverFront Support Bracket	1
3	Driver Center Big Bracket	1
4	Driver Rear Bracket	1
5	PassengerFront Bracket	1
6	PassengerFront Support Bracket	1
7	Passenger Center Big Bracket	1
8	Passenger Rear Bracket	1
9	U Bolt	6
10	HTC 232 - M10x20	2
11	HTC 243 - M10x25(4x12x50)	2
12	HTC 269 - CLIPS (M10)	4
13	M10 - Washer	12
14	M10 - Hex Flange Nut	18
15	M10 x 25 - Hex Flange Bolt	2



# Box Contents

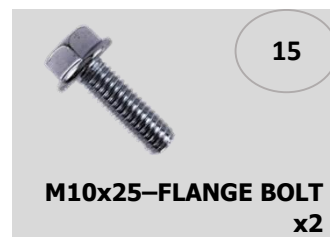
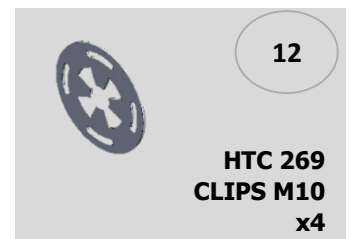
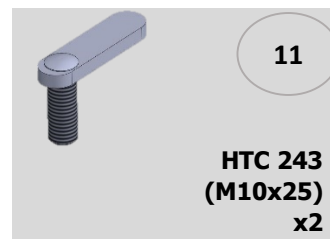
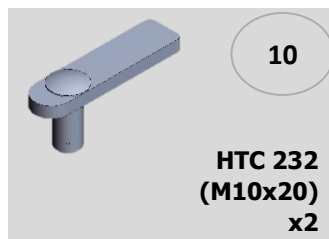
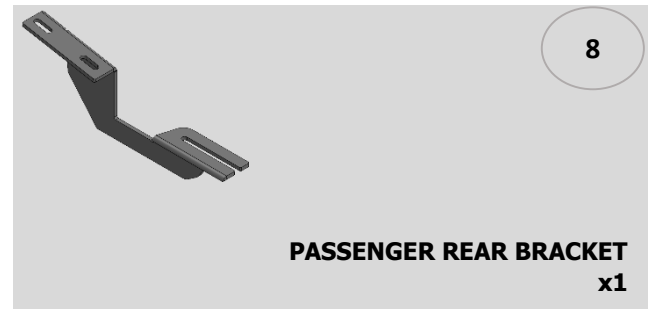
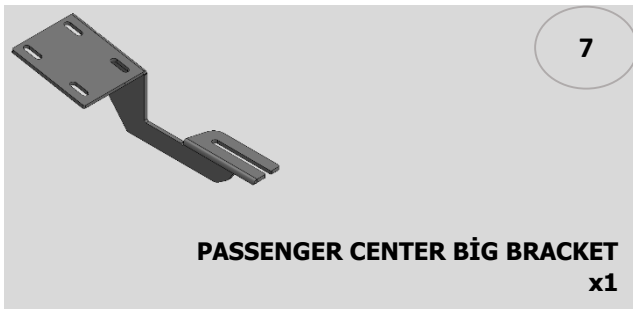
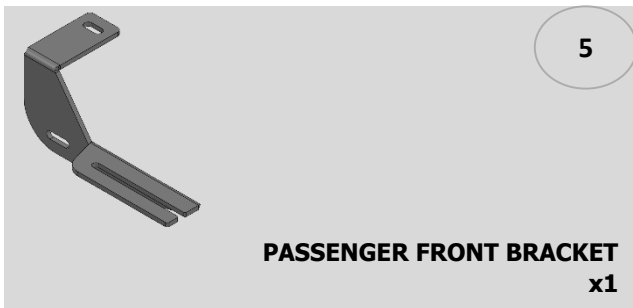
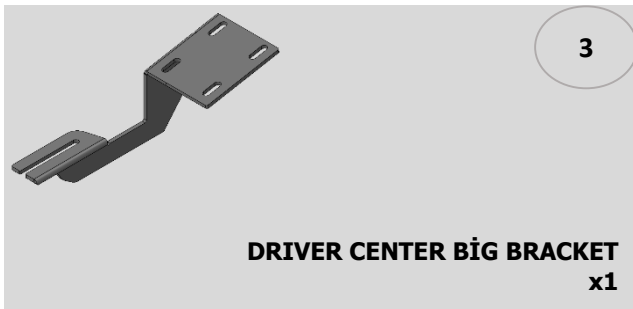

# Brackets Assembly

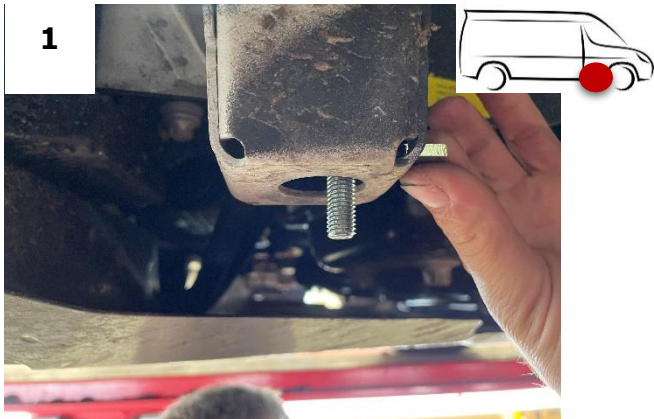

Install the HTC 232.



Install the HTC 243.



Bracket is mounted as shown.

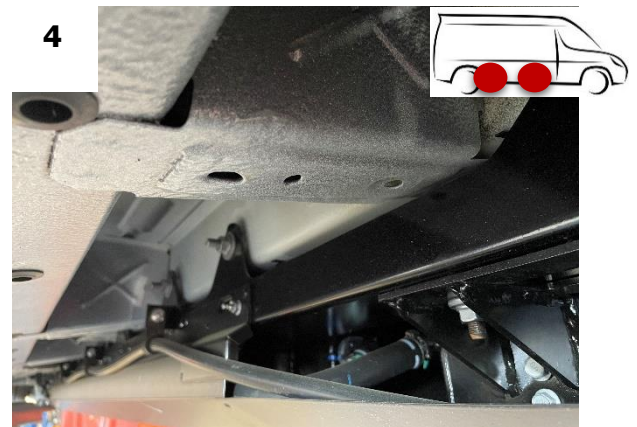

U bolt junction area.



U bolt is connected as shown.

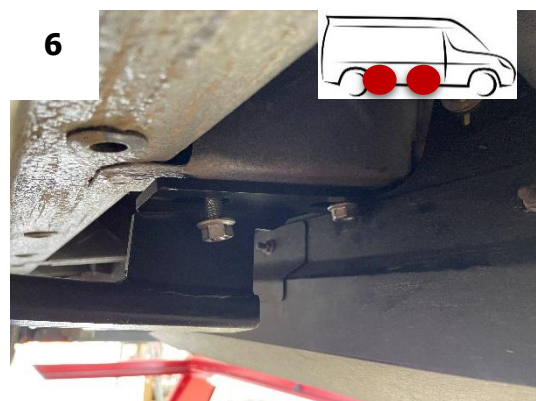

Place bracket on the U bolt

**ATT Note:**

**If not possible bij Exhaust pipe change 3 + 7**