

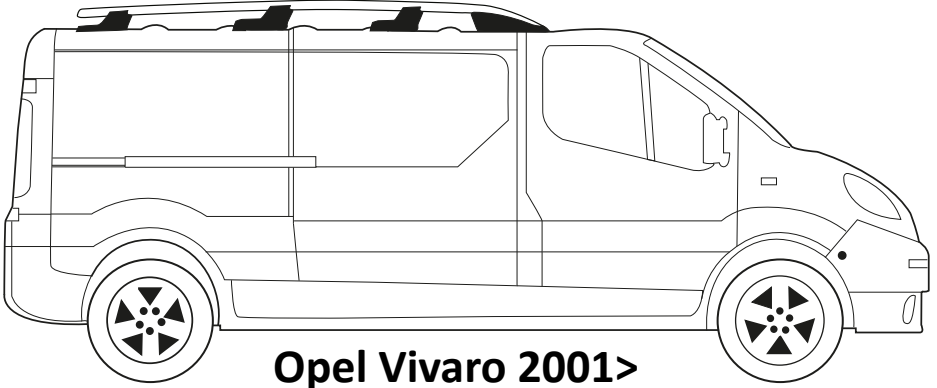

ONTEC
AUTO ACCESSORIES.CO



**Opel Vivaro 2001>
Renault Trafic 2001>
Nissan Primastar 2001>**

TR	Montaj Talimatı	:	PORT BAGAJ
GB	Fitting Instructions	:	ROOF RAIL
D	Montageanleitung	:	DACHREILING
F	Instructions de Montage	:	RIDELLES DE TOIT

TR

*Port bagaj taşıma kapasitesi 75 kg. olup; yüklemeye yapmadan önce aracın tavan taşıma kapasitesinin dikkate alınması gerekir.

GB

*Roof Rack carrying capacity is maximum 75 kg. Please check your vehicle roof maximum carrying capacity from your car manufacturer before load roof rack.

G

*Maximale Traglast unsere Dachrelinge betragen 75kg. Die freigegebenen Dachlasten der Fahrzeughersteller dürfen nicht überschritten werden. Bitte zur Kenntnisnahme!

F

*La capacité de chargement maximale est de 75 Kg. Nous vous prions de vérifier la capacité de chargement du toit de votre véhicule avant de charger les barres de toit.



30 Min.



PARÇA LİSTESİ

Part List / Teilleiste / Lista de accesorios

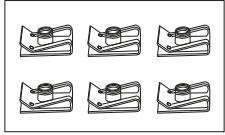

- (TR) KLİPSLİ SOMUN = 6 PARÇA
- (GB) CLIP NUT = 6 PIECES
- (D) U SCHELLENMUTTER = 6 STÜCK
- (F) ÉCROU DE COLLIER = 6 PIÈCES

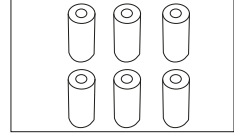

- (TR) YÜKSEK CONTA = 6 PARÇA
- (GB) HIGH PLASTIC WASHER = 6 PIECES
- (D) KUNSTSTOFF UNTERLEGSCHLEIBEN = 6 STÜCK
- (F) L'HAUTE RONDELLE EN PLASTIQUE = 6 PIÈCES

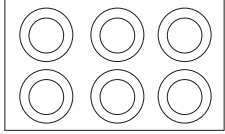

- (TR) PUL = 6 PARÇA
- (GB) RING WASHER = 6 PIECES
- (D) UNTERLEGSCHLEIBE = 6 STÜCK
- (F) RONDELLE AUTOBLOQUANTE = 6 PIÈCES

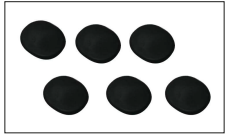

- (TR) PLASTİK TAPA = 6 PARÇA
- (GB) PLASTIC PLUG = 6 PIECES
- (D) GUMMISTOPFEN = 6 STÜCK
- (F) BOUCHON PLASTIQUE = 6 PIÈCES

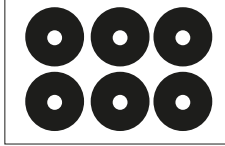

- (TR) SIZDIRMAZLIK ELEMANI = 6 PARÇA
- (GB) IMPERMEABLE RUBBER = 6 PIECES
- (D) KUNSTSTOFF-DICHTUNG = 6 STÜCK
- (F) JOINT EN PLASTIQUE = 6 PIÈCES

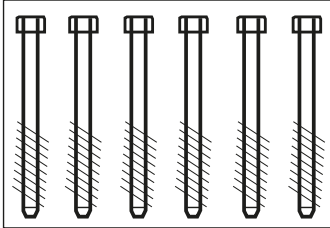
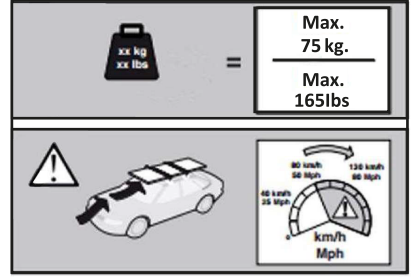

m-6 x 70 (FRONT-MIDDLE-REAR)

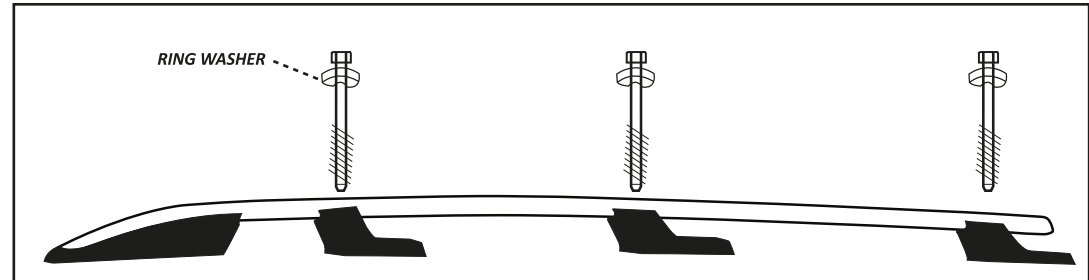

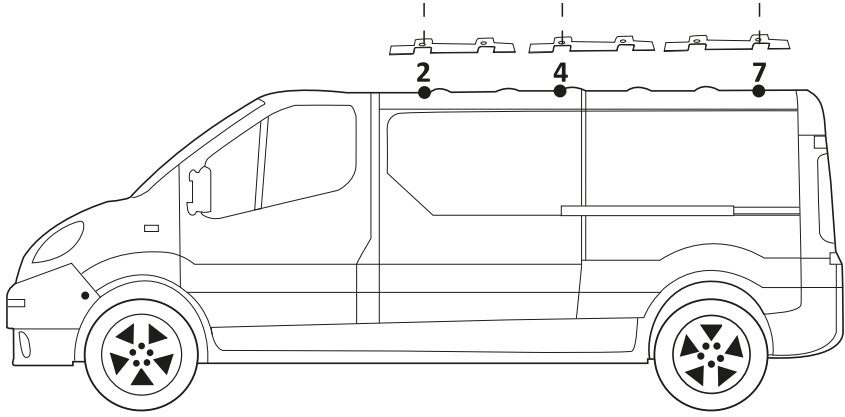

1) Klipsli somunu, araç üzerindeki metal çıkıntılardan numaralarla belirtilmiş olanların altına yerleştirin. (2-4-7)

1) Please place the nut (with clips) under the numbered (2-4 and 7) metal bulges as it shown.

1) Siehe Abbildung. Nummeriert auf Fahrzeug stellen Sie die Untere Schellenmutter auf den Metalllaschen.

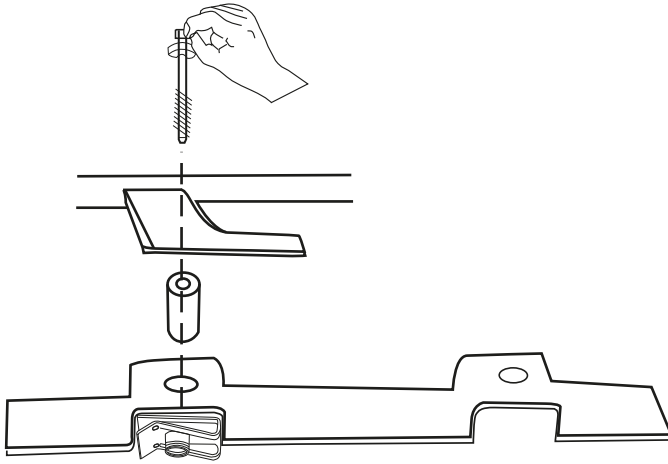

2) Yüksek contayı da aracın metal çıkıntısının ve klipsli somunun üzerine gelecek şekilde yerleştirip vida ile birlikte sıkarak sabitleyin.

2) The high gasket should be placed to the top of metal bulges and nut (with clips) then tightened up by screw.

2) Legen Sie die Kunststoffunterlegscheiben in die Öffnung über die unter Schellenmutter und befestigen Sie diese mit der Schraube zusammen.

3) Belirtilen işlemleri 2, 4 ve 7 numaralı delikler için uygulayın. İşlemleri tamamladığınızda port bagajınız kullanıma hazır durumda olacaktır

3) Please follow the same process for the numbered holes (2,4 and 7) then you may get the recommended result for your roof rail installation.

3) In der Abbildung angegebenen Nr. 2,4,7 ausführen. Sobald Sie dies ausgeführt haben sind die Dachrelinge einsatz bereit.

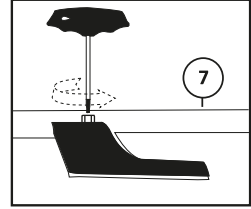
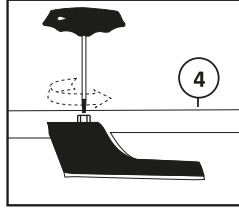
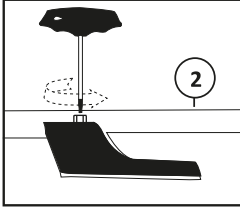

4) Port bagajı araç üzerine montaj yerlerinden sabitleyip sıkınız.

4) Align the holes in each rails with the hole on the roof then install roof rails by tightening the screws.

4) Fixieren Sie den Dachträger an den Montierstellen und befestigen Sie diesen.

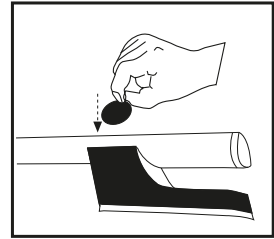
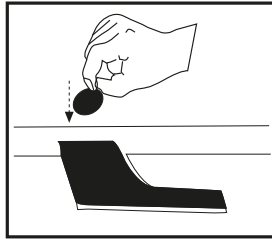
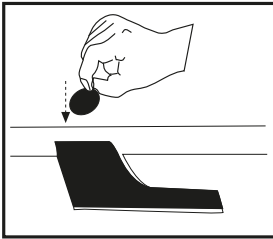

5) Port bagajın tapalarını yerlerine yerleştirerek montajı tamamlayın.

5) Tap the plugs on roof rails.

5) Stecken Sie die Stopper in Ihre Plätze und schließen Sie diese.