



**Mercedes (e) Citan 2022+  
Renault Kangoo ( E-tech) 2022+  
Nissan Townstar ( Electric) 2022+**

**INSTALLATION GUIDE**



Mercedes (e) Citan 2022+ Renault Kangoo ( E-tech) 2022+ Nissan Townstar ( Electric) 2022+	15.11.2022	1
---	------------	---

60 min.

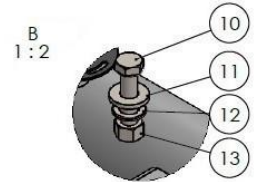
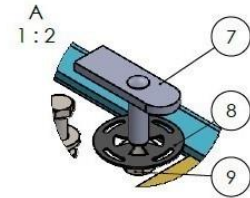
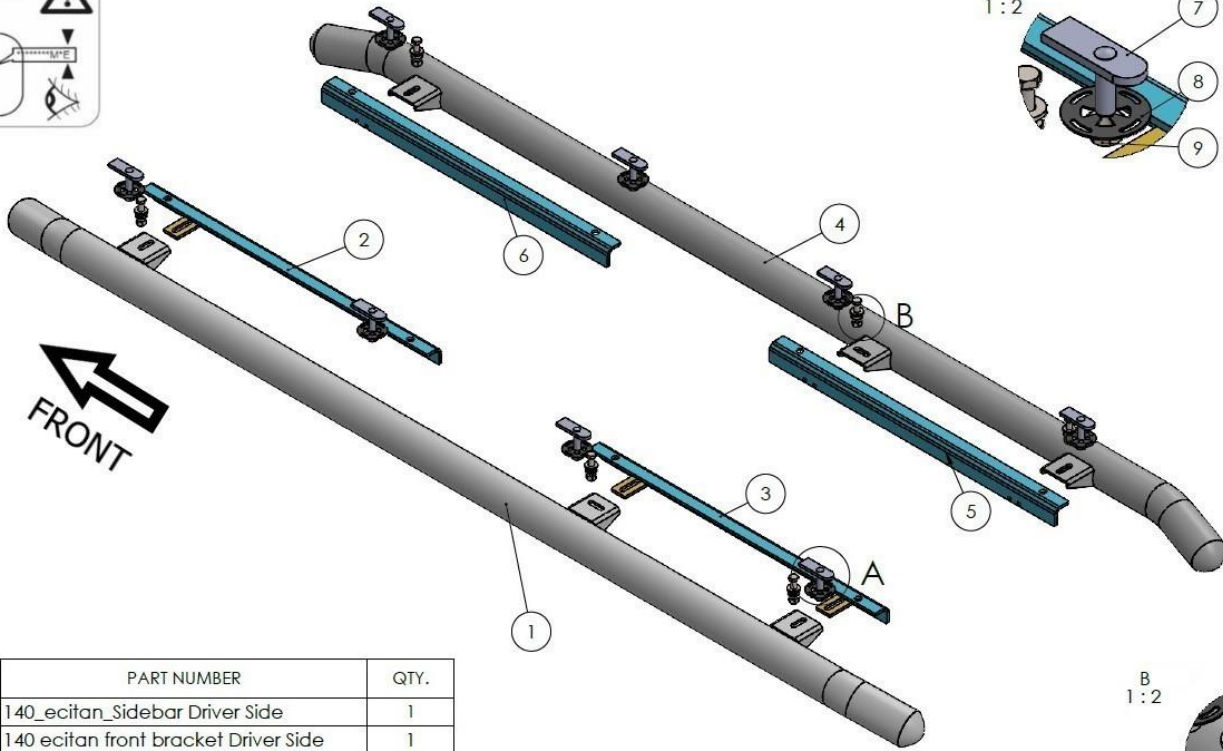
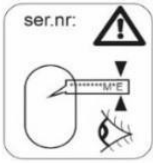

ITEM NO.	PART NUMBER	QTY.
1	140_ecitan_Sidebar Driver Side	1
2	140 ecitan front bracket Driver Side	1
3	140 ecitan rear bracket Driver Side	1
4	140_ecitan_Sidebar Passenger Side	1
5	140 ecitan rear bracket Passenger Side	1
6	140 ecitan front bracket Passenger Side	1
7	HTC 238 - M10x25(4x20x60)	8
8	HTC 269 - CLIPS (M10)	8
9	M10 Self-locking Nuts	8
10	M8x40 Bolt	6
11	M8 Washer	6
12	M8 Nut Self-locking Nuts	6



M6 = 10 Nm  
M8 = 25 Nm  
M10 = 50 Nm

# Box Contents

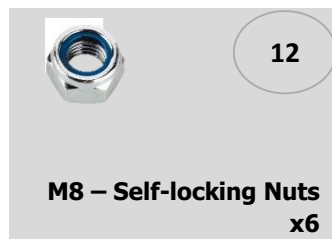
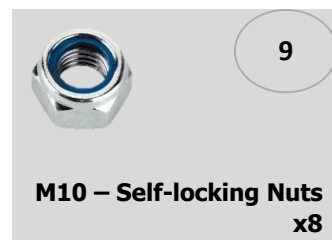
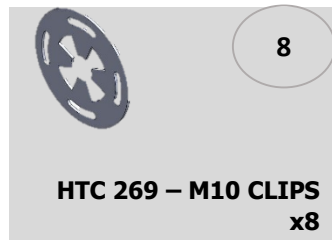
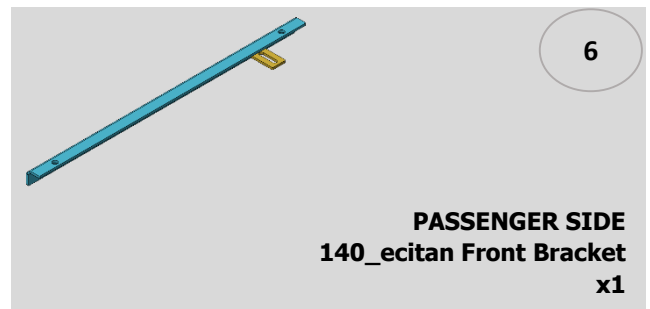
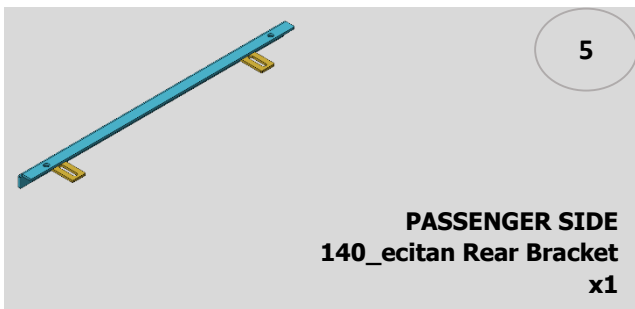
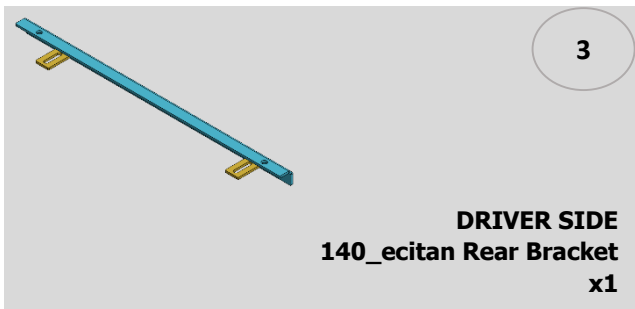
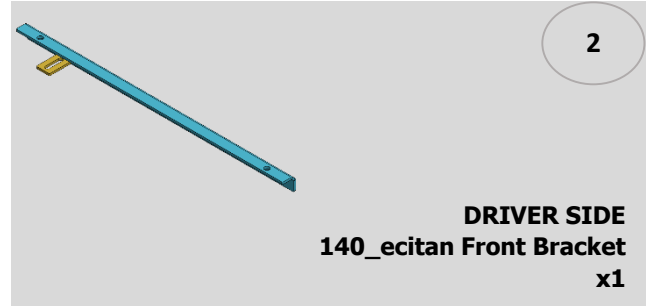

## Brackets Assembly

1



Remove covers from sill of car. (4x)

2



Place HTC238 into the slot. (4x)

3



Place bracket to the body of the car and connect with Nut (4X)

## REPEAT FOR OTHER SIDE

### Side Steps Assembly

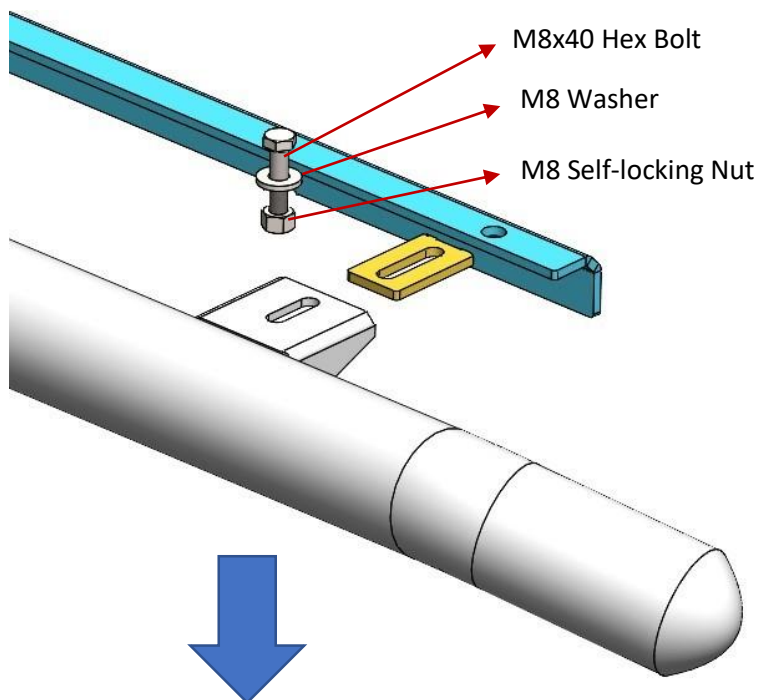

Place sidebar to the brackets (bolts) and tighten them with nuts and rivets.

Tighten everything with correct moment and replace bottom cover.

