

Mounting instructions

Side bar series: GM - GC- RM - RC - BM - BC

Maxus e-Deliver 9



SW13 (23 Nm)



SW15 (?? Nm)



SW17 (46 Nm)



60 Min.

Version: 1.00 December 2021



	①	M8x40 Bolt	4X		⑧	HTCOR3	2X
	②	M8 Wide Washer	8X		⑨	M10x40 Bolt	2X
	③	M8 Nut	4X		⑩	M10x25 Flange bolt	4X
	④	HTCOR2 (M8)	4X		⑪	M10 Flange Nut	4X
	⑤	HTCOR4 (M10)	2X		⑫	M10 Wide washer	8X
	⑥	HTC 243 - M10x25 (5x13x50)	2X		⑬	M10 Spring Washer	2X
	⑦	HTC 230 - M10x25 (4x20x60)	2X		⑭	HTC 269 Klips (M10)	2X

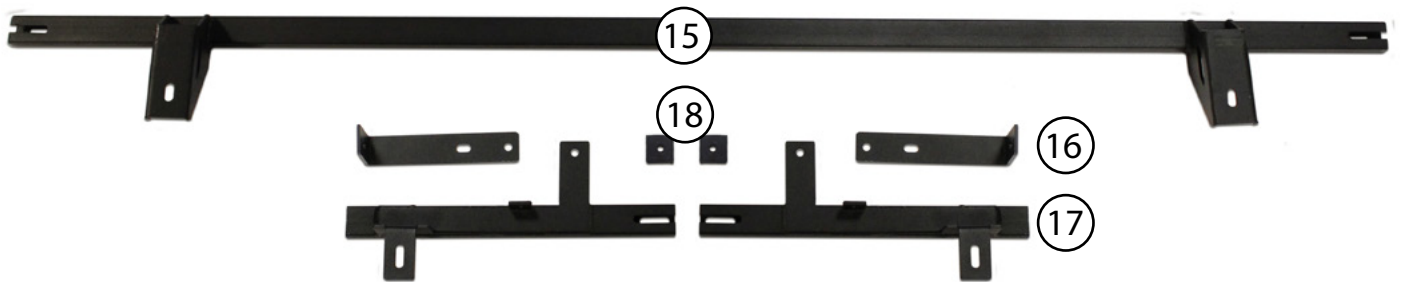

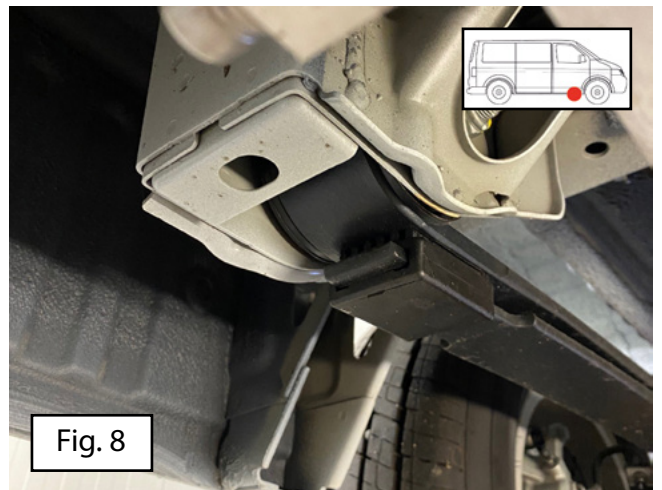
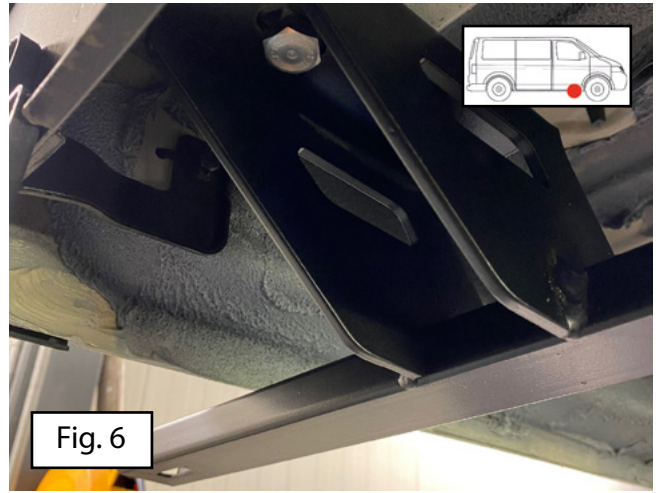
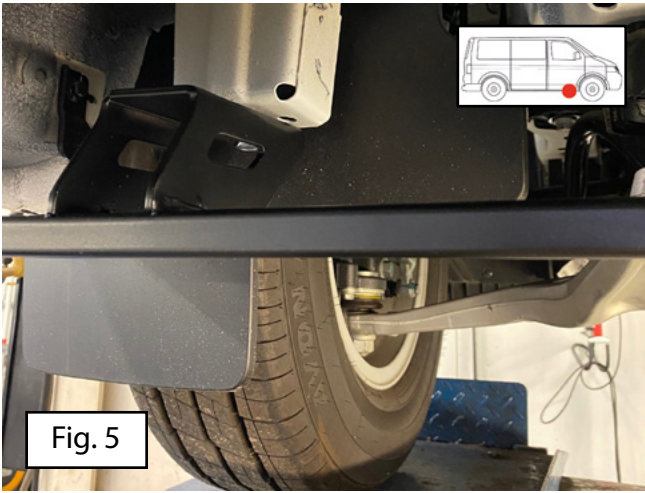
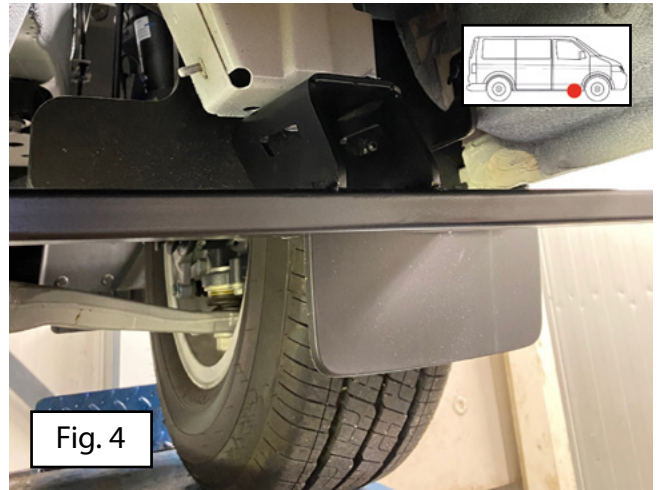
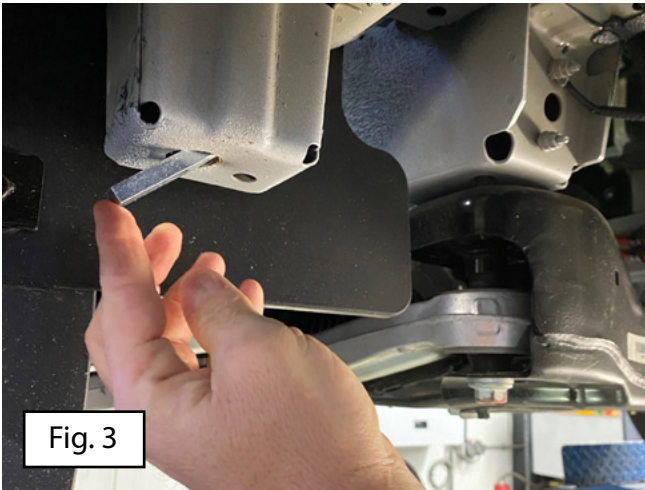
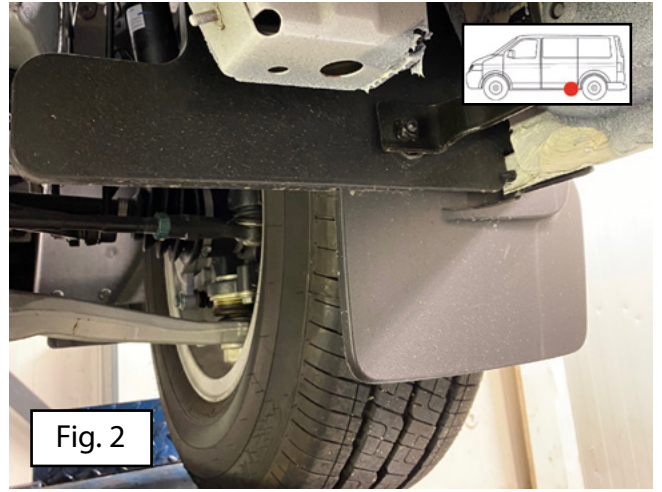
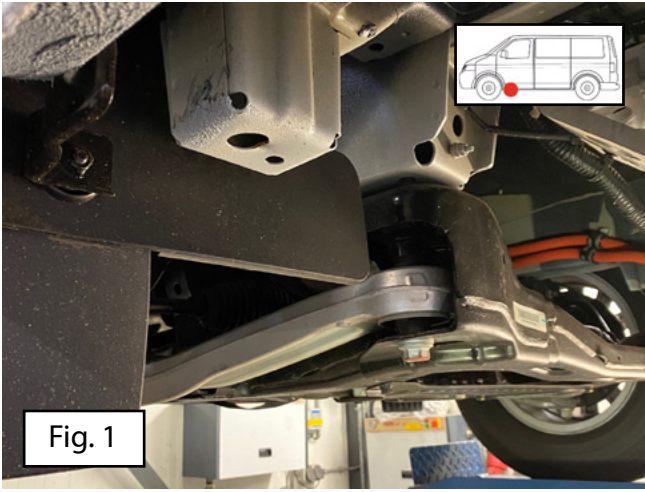

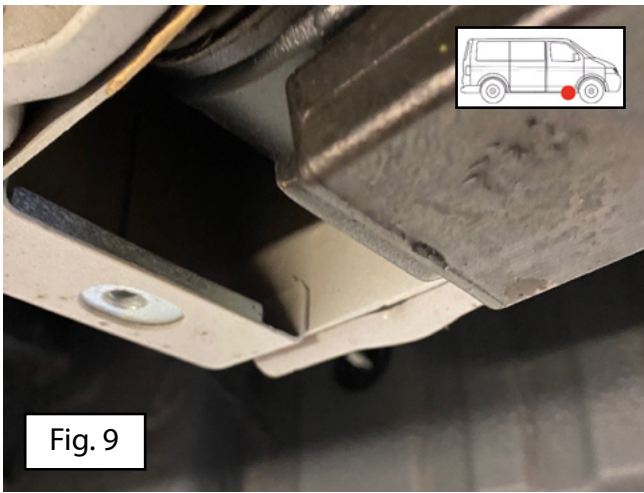

Fig. 9



Fig. 10

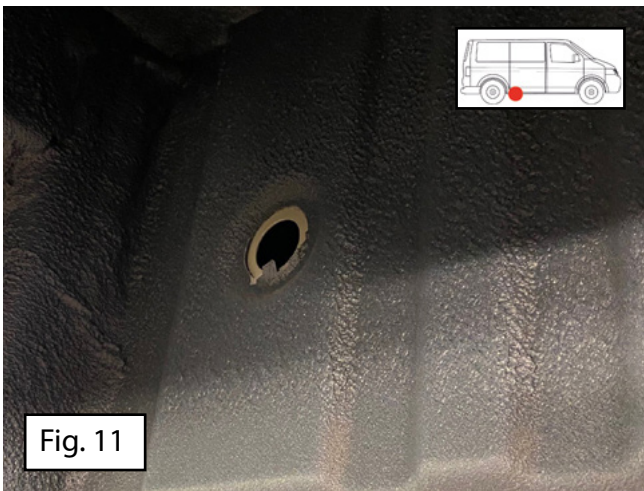

Fig. 11

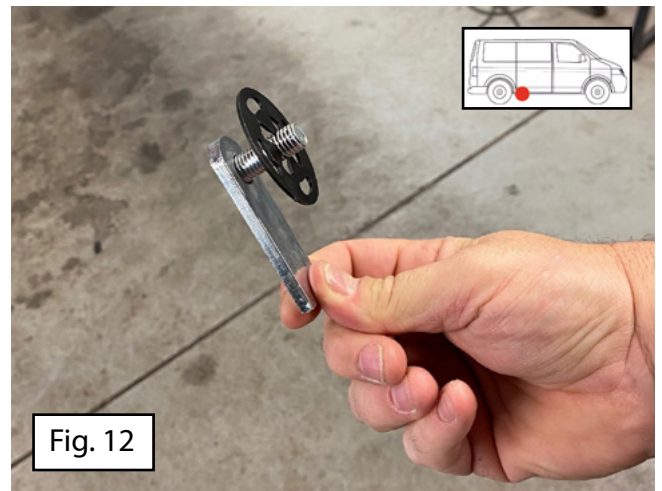

Fig. 12

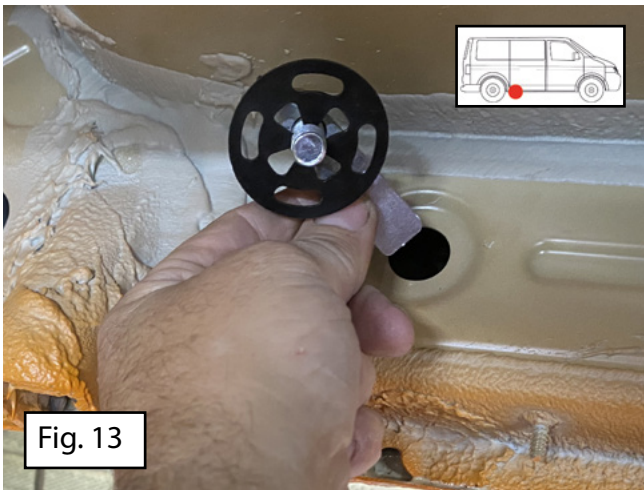

Fig. 13

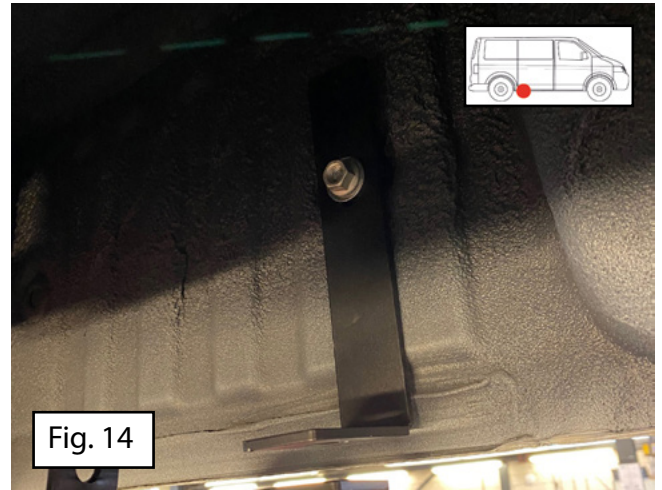

Fig. 14

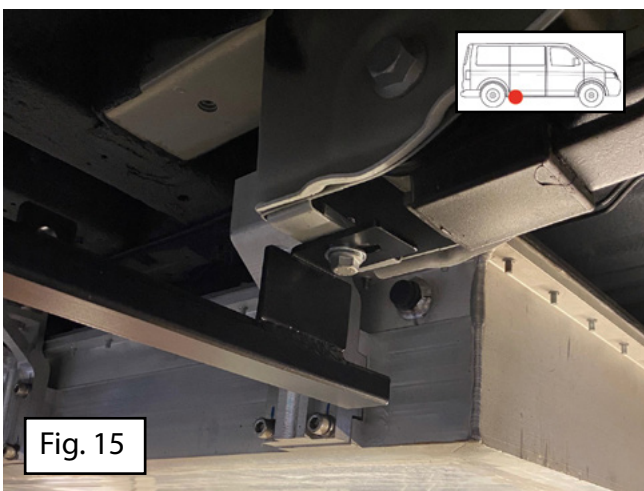

Fig. 15

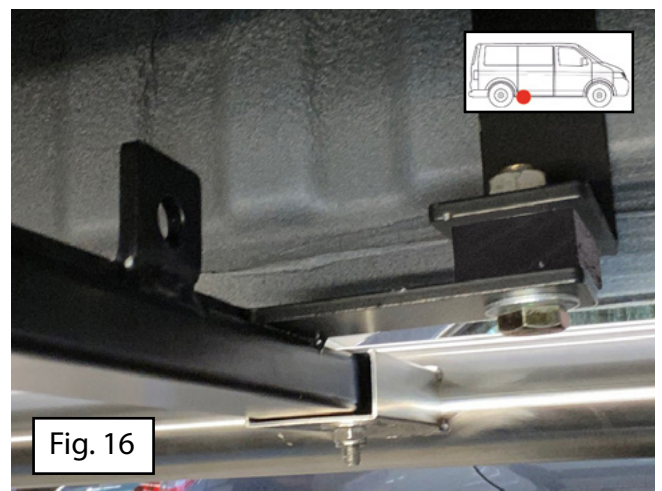
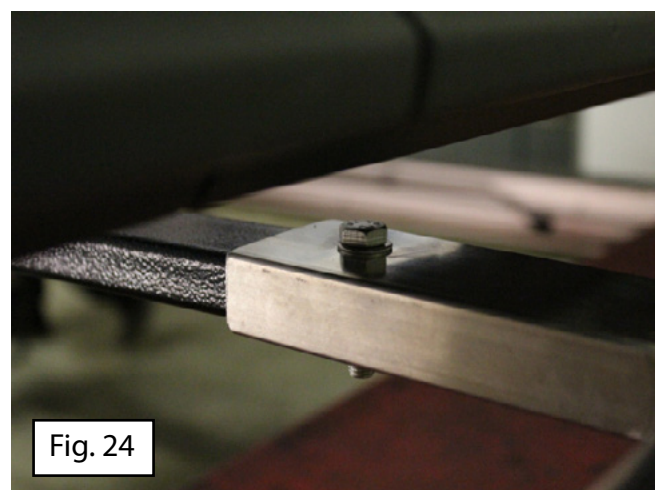
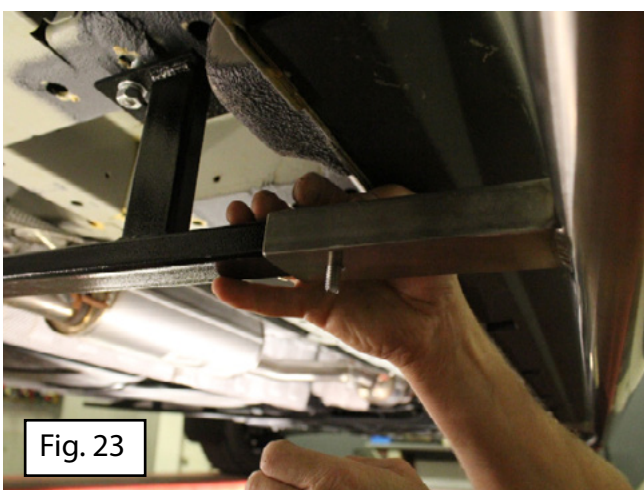
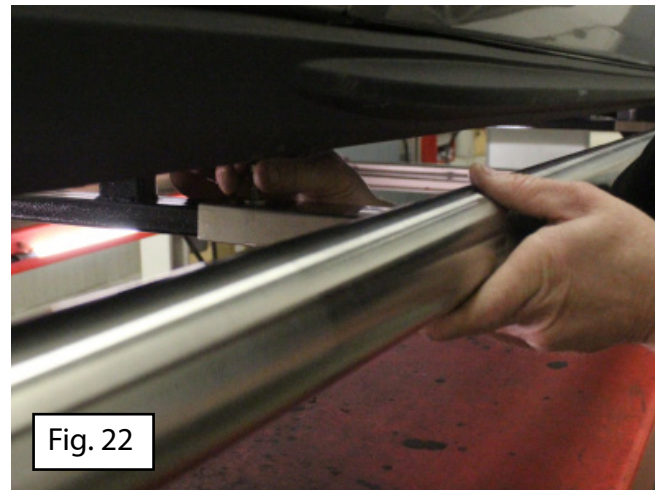
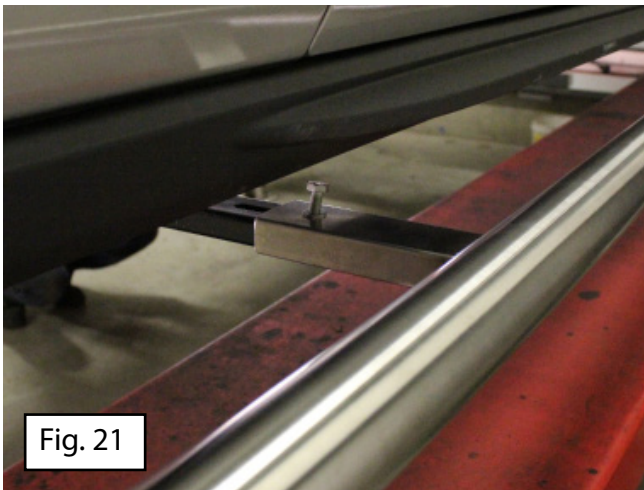
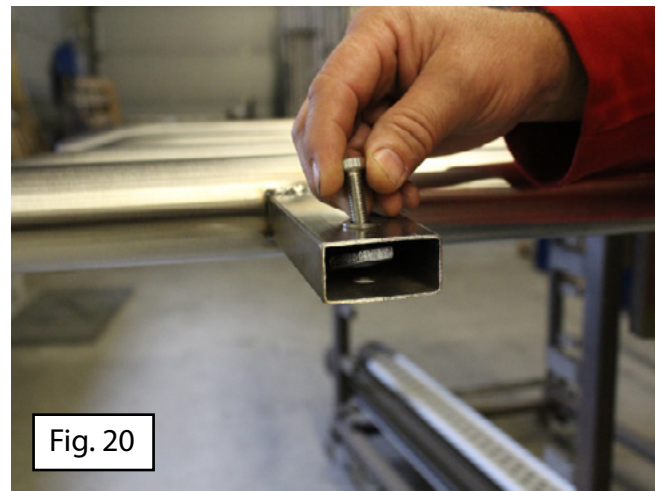
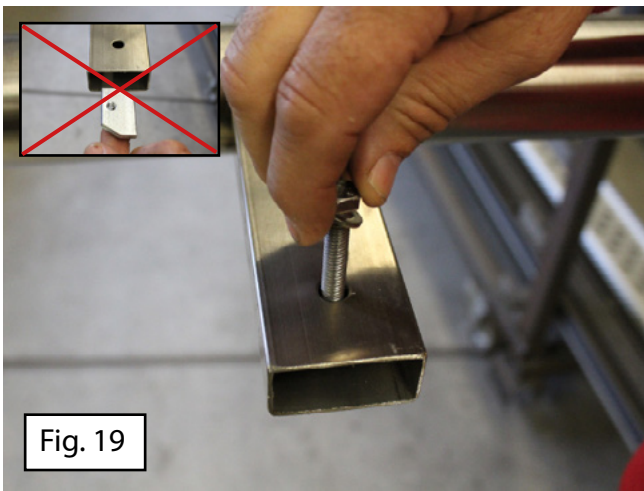
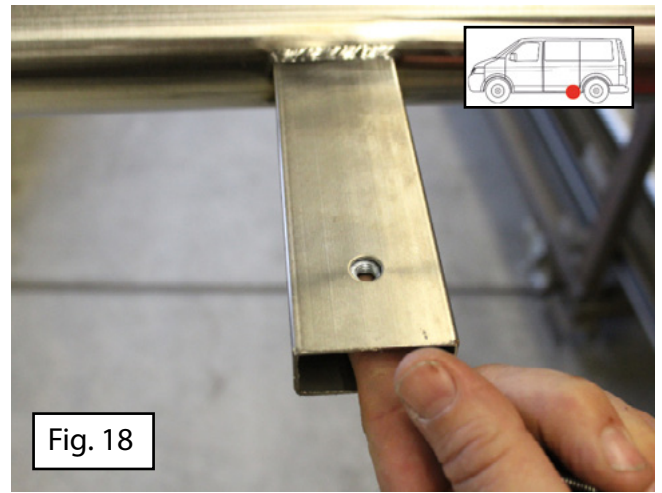
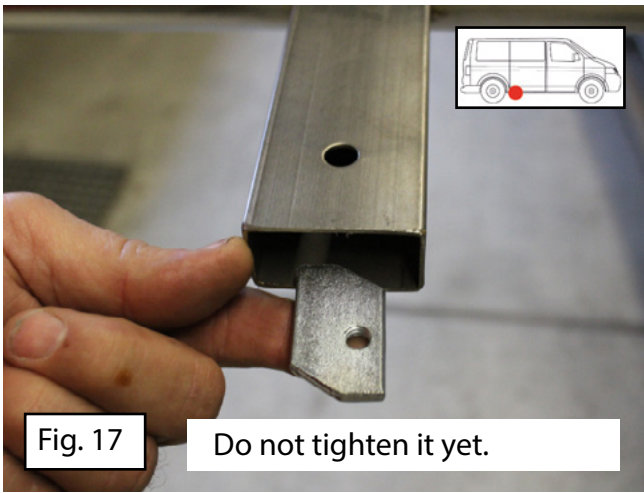
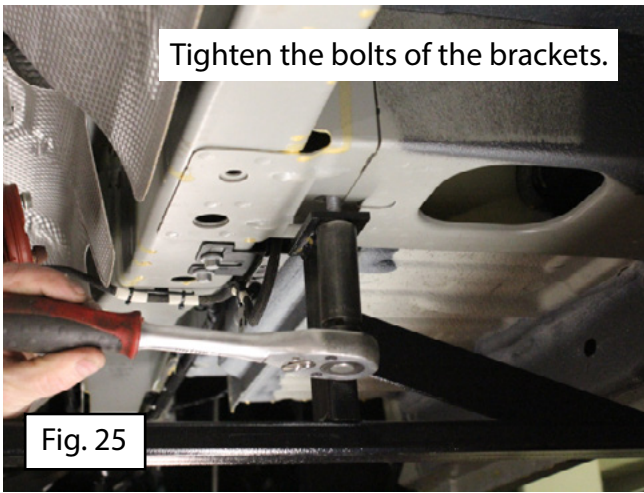

Fig. 16





Tighten the bolts of the brackets.

Fig. 25



Slide the Side bar to the desired distance.

Fig. 26

Do not tighten it yet.

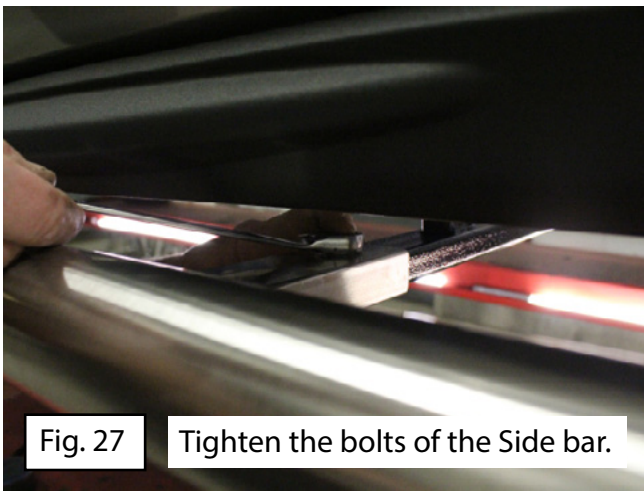

Tighten the bolts of the Side bar.

Fig. 27



Use grease

Fig. 28

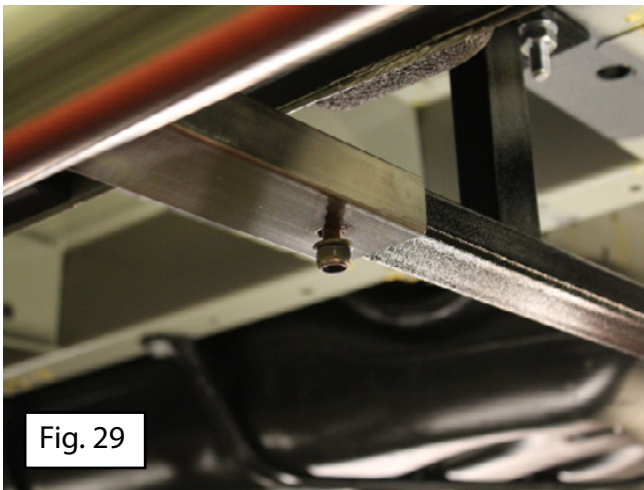

Fig. 29

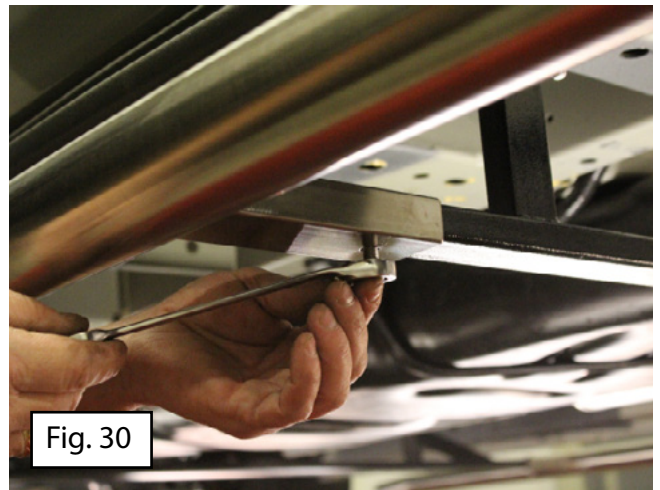

Fig. 30